

SMC TRANSIENT VOLTAGE SUPPRESSOR

FEATURES

- 3000W peak pulse capability @ 10 x 1000us waveform, repetition rate (duty cycle): 0.01%
- Optimized for LAN protection applications
- Low incremental surge resistance
- excellent clamping capability
- Fast response time: typically less than 1ps from 0 Volts to V(BR) for uni-directional and 5.0ns for bi-directional types
- High temperature soldering guaranteed: 250° C/10 seconds at terminals

MECHANICAL DATA

- Case style: SMC plastic molded
- Polarity: color band denotes positive end(cathode) except for bidirectional
- Mounting position: any

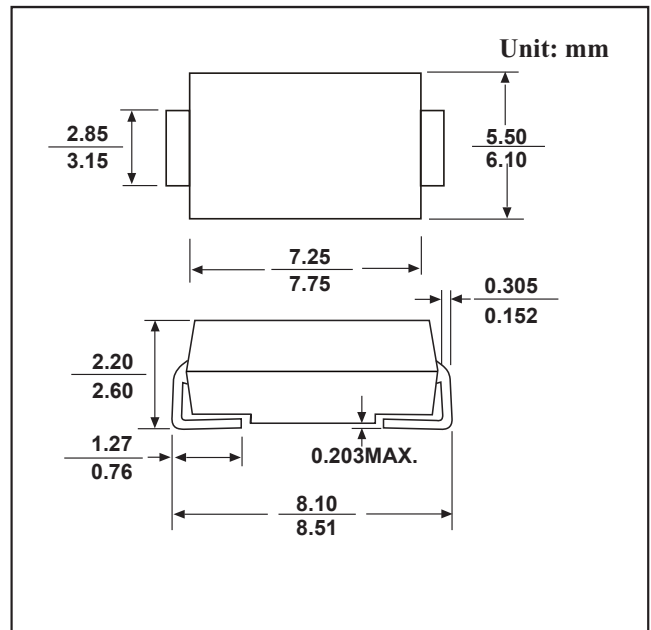

DEVICES FOR BIDIRECTIONAL APPLICATIONS

For bidirectional use C or CA suffix for types 1.5KE6.8 thru 1.5KE540(e.g. 1.5KE6.8C, 1.5KE440CA)

Electrical characteristics apply in both directions.

MAXIMUM RATINGS AND CHARACTERISTICS

@ 25°C Ambient Temperature (unless otherwise noted)

Parameter	Symbol	Value	Units
Peak Power Dissipation (Note 1.) @ $T_L = 25^\circ\text{C}$, Pulse Width = 1 ms	PPK	3000	W
Forward Surge Current (Note 2.) @ $T_A = 25^\circ\text{C}$	IFSM	200	A
Power Dissipation On Infinite Heatsink, @ $T_A = 50^\circ\text{C}$	PM(AV)	5.0	W
Thermal Resistance Junction To Ambient Air (Note 3.)	R θ JA	75	°C/W
Thermal Resistance Junction To Leads	R θ JL	15	°C/W
Storage Temperature Range	TSTG	-55 to 150	°C
Operating Junction Temperature Range	T $_J$	-55 to 150	°C

1) 10 X 1000 us, non-repetitive

2) 1/2 sine wave (or equivalent square wave), PW = 8.3 ms, duty cycle = 4 pulses per minute maximum 3) Mounted on minimum recommended pad layout

Electrical Specification (T_A=25°C unless otherwise specified)

Part Number	Part Number	Device Marking Code		Reverse Stand off Voltage VR (Volts)	Breakdown Voltage VBR (Volts) @ IT		Test Current IT (mA)	Maximum Clamping Voltage VC @ IPP (Volts)	Maximum Peak Pulse Current IPP (A)	Maximum Reverse Leakage IR @ VR (μA)
		UNI	BI		MIN	MAX				
3.0SMDJ5.0A	3.0SMDJ5.0CA	HDE	IDE	5	6.4	7.07	10	9.2	326.1	500
3.0SMDJ6.0A	3.0SMDJ6.0CA	HDG	IDG	6	6.67	7.37	10	10.3	291.3	500
3.0SMDJ6.5A	3.0SMDJ6.5CA	HDK	IDK	6.5	7.22	7.98	10	11.2	267.9	300
3.0SMDJ7.0A	3.0SMDJ7.0CA	HDM	IDM	7	7.78	8.6	10	12	250.0	200
3.0SMDJ7.5A	3.0SMDJ7.5CA	HDP	IDP	7.5	8.33	9.21	1	12.9	232.6	100
3.0SMDJ8.0A	3.0SMDJ8.0CA	HDR	IDR	8	8.89	9.83	1	13.6	220.6	50
3.0SMDJ8.5A	3.0SMDJ8.5CA	HDT	IDT	8.5	9.44	10.4	1	14.4	208.3	30
3.0SMDJ9.0A	3.0SMDJ9.0CA	HDV	IDV	9	10	11.1	1	15.4	194.8	30
3.0SMDJ10A	3.0SMDJ10CA	HDX	IDX	10	11.1	12.3	1	17	176.5	5
3.0SMDJ11A	3.0SMDJ11CA	HDZ	IDZ	11	12.2	13.5	1	18.2	164.8	1
3.0SMDJ12A	3.0SMDJ12CA	HEE	IEE	12	13.3	14.7	1	19.9	150.8	1
3.0SMDJ13A	3.0SMDJ13CA	HEG	IEG	13	14.4	15.9	1	21.5	139.5	1
3.0SMDJ14A	3.0SMDJ14CA	HEK	IEK	14	15.6	17.2	1	23.2	129.3	1
3.0SMDJ15A	3.0SMDJ15CA	HEM	IEM	15	16.7	18.5	1	24.4	123.0	1
3.0SMDJ16A	3.0SMDJ16CA	HEP	IEP	16	17.8	19.7	1	26	115.4	1
3.0SMDJ17A	3.0SMDJ17CA	HER	IER	17	18.9	20.9	1	27.6	108.7	1
3.0SMDJ18A	3.0SMDJ18CA	HET	IET	18	20	22.1	1	29.2	102.7	1
3.0SMDJ20A	3.0SMDJ20CA	HEV	IEV	20	22.2	24.5	1	32.4	92.6	1
3.0SMDJ22A	3.0SMDJ22CA	HEX	IEX	22	24.4	26.9	1	35.5	84.5	1
3.0SMDJ24A	3.0SMDJ24CA	HEZ	IEZ	24	26.7	29.5	1	38.9	77.1	1
3.0SMDJ26A	3.0SMDJ26CA	HFE	IFE	26	28.9	31.9	1	42.1	71.3	1
3.0SMDJ28A	3.0SMDJ28CA	HFG	IFG	28	31.1	34.4	1	45.4	66.1	1
3.0SMDJ30A	3.0SMDJ30CA	HFK	IFK	30	33.3	36.8	1	48.4	62.0	1
3.0SMDJ33A	3.0SMDJ33CA	HFM	IFM	33	36.7	40.6	1	53.3	56.3	1
3.0SMDJ36A	3.0SMDJ36CA	HFP	IFP	36	40	44.2	1	58.1	51.6	1
3.0SMDJ40A	3.0SMDJ40CA	HFR	IFR	40	44.4	49.1	1	64.5	46.5	1
3.0SMDJ43A	3.0SMDJ43CA	HFT	IFT	43	47.8	52.8	1	69.4	43.2	1
3.0SMDJ45A	3.0SMDJ45CA	HFV	IFV	45	50	55.3	1	72.7	41.3	1
3.0SMDJ48A	3.0SMDJ48CA	HFX	IFX	48	53.3	58.9	1	77.4	38.8	1
3.0SMDJ51A	3.0SMDJ51CA	HFZ	IFZ	51	56.7	62.7	1	82.4	36.4	1
3.0SMDJ54A	3.0SMDJ54CA	HGE	IGE	54	60	66.3	1	87.1	34.4	1
3.0SMDJ58A	3.0SMDJ58CA	HGG	IGG	58	64.4	71.2	1	93.6	32.1	1
3.0SMDJ60A	3.0SMDJ60CA	HGK	IGK	60	66.7	73.7	1	96.8	31.0	1
3.0SMDJ64A	3.0SMDJ64CA	HGM	IGM	64	71.1	78.6	1	103	29.1	1

Electrical Specification (T_A=25°C unless otherwise specified)

Part Number	Part Number	Device Marking Code		Reverse Stand off Voltage VR (Volts)	Breakdown Voltage VBR (Volts) @ IT		Test Current IT (mA)	Maximum Clamping Voltage VC @ IPP (Volts)	Maximum Peak Pulse Current IPP (A)	Maximum Reverse Leakage IR @ VR (μA)
		UNI	BI		MIN	MAX				
3.0SMDJ70A	3.0SMDJ70CA	HGP	IGP	70	77.8	86	1	113	26.5	1
3.0SMDJ75A	3.0SMDJ75CA	HGR	IGR	75	83.3	92.1	1	121	24.8	1
3.0SMDJ78A	3.0SMDJ78CA	HGT	IGT	78	86.7	95.8	1	126	23.8	1
3.0SMDJ85A	3.0SMDJ85CA	HGV	IGV	85	94.4	104	1	137	21.9	1
3.0SMDJ90A	3.0SMDJ90CA	HGX	IGX	90	100	111	1	146	20.5	1
3.0SMDJ100A	3.0SMDJ100CA	HGZ	IGZ	100	111	123	1	162	18.5	1
3.0SMDJ110A	3.0SMDJ110CA	HHE	IHE	110	122	135	1	177	16.9	1
3.0SMDJ120A	3.0SMDJ120CA	HHG	IHG	120	133	147	1	193	15.5	1
3.0SMDJ130A	3.0SMDJ130CA	HHK	IHK	130	144	159	1	209	14.4	1
3.0SMDJ150A	3.0SMDJ150CA	HHM	IHM	150	167	185	1	243	12.3	1
3.0SMDJ160A	3.0SMDJ160CA	HHP	IHP	160	178	197	1	259	11.6	1
3.0SMDJ170A	3.0SMDJ170CA	HHR	IHR	170	189	209	1	275	10.9	1

※For Bi-directional type having VRWM of 10 Volts and less, the IR limit is double

1. A transient suppressor is normally selected according to the working peak reverse voltage (VRWM), which should be equal to or greater than the DC or continuous peak operating voltage level.
2. VBR measured at pulse test current IT at an ambient temperature of 25°C.
3. Surge current waveform per Figure 1 and derate per Figure 3.

RATINGS AND CHARACTERISTIC CURVES

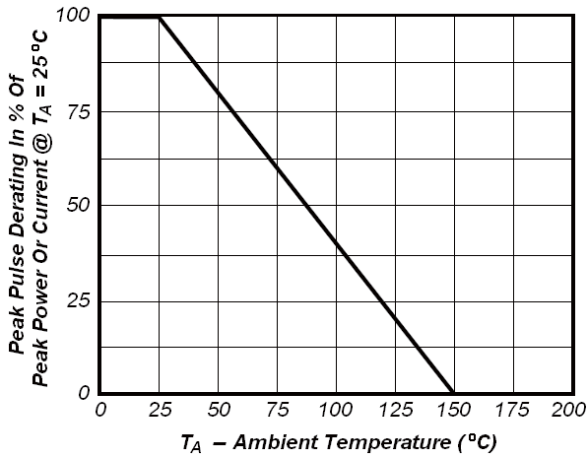

Fig1. Pulse Dearing Curve

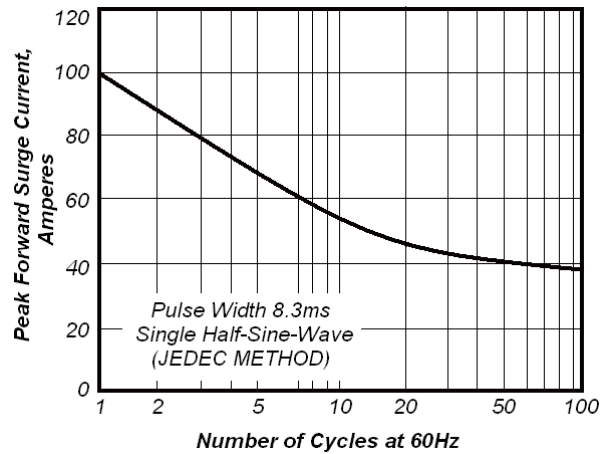

Fig2. Maximum Non-Repetitive Peak Forward Surge Current

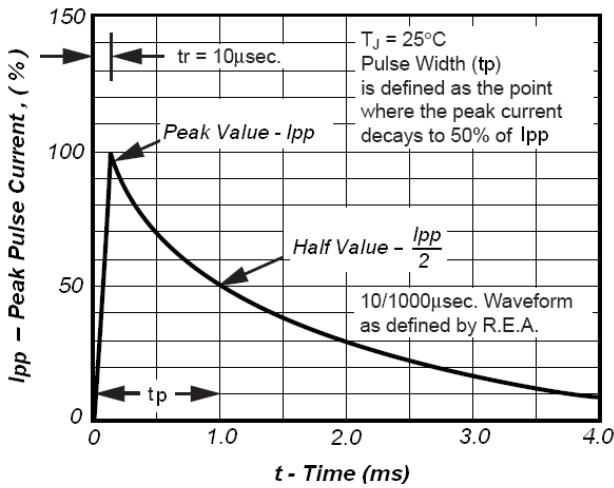

Fig3. Pulse Waveform

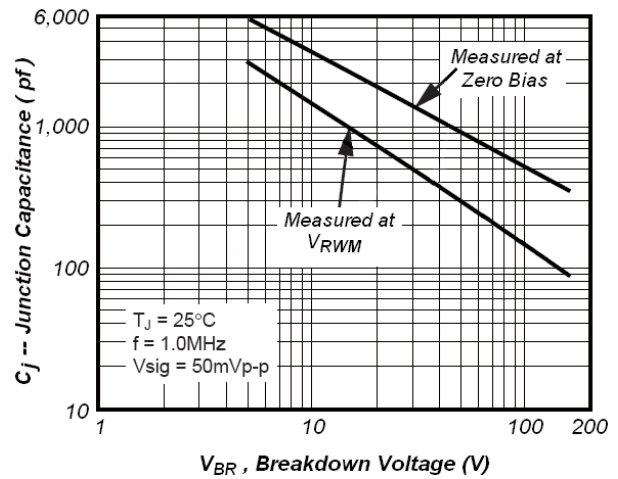

Fig4. Typical Junction Capacitance

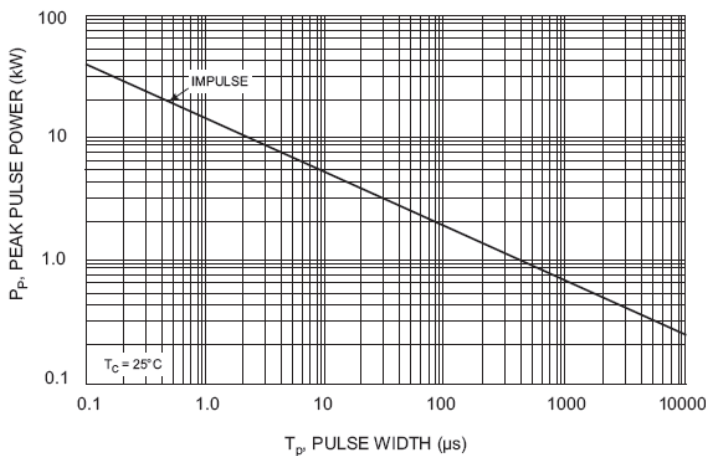

Fig5. Peak Pulse Power Rating curve

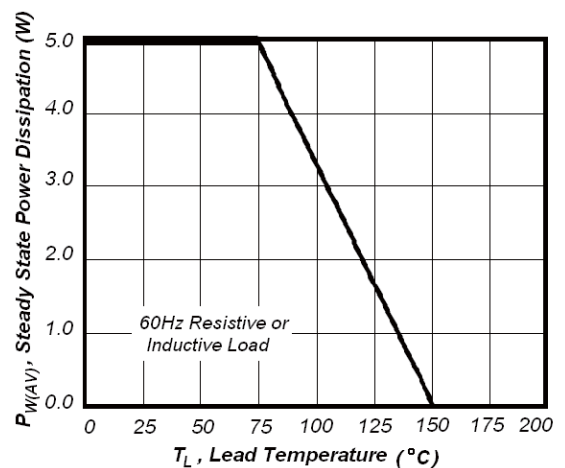

Fig6. Steady State Power Derating Curve